

ARRAY5	ARRAY7	ARRAY8	ARRAY9	C	C_	C_VARICAP	CAP
N????	N????	N????	N????	C????	C????	D???	C???

CE	CE_	CERFILT	CERFILT_D	CERFILT_S	CEU_	CN_SIL8
C????	C????	FI??	FI??	FI??	C????	CN???

CN_SIL9	COAXRES	CS_	CS_VARI	CT01	CT_	CT_01	CTRIM
CN???	MR??	C????	D???	C????	C????	C????	C???

DIPSW4	DIPSW7	DIPSW8	ELKO	F	F_	FUSE
N????	N????	N????	C???	F????	F????	FU??

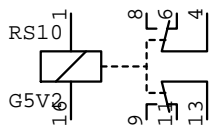

G5V\_2  
RS???

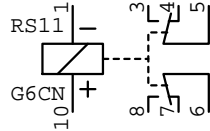

G6CN\_2\_BS  
RS???

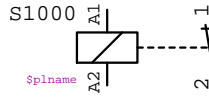

K1E1O  
S????

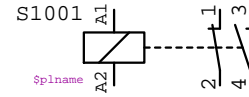

K1E1O1S  
S????

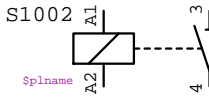

K1E1S  
S????

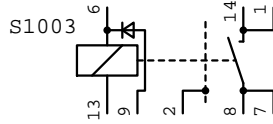

K1E1S\_RDILDS  
S????

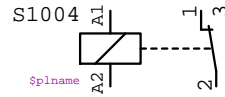

K1E1W  
S????

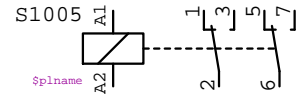

K1E2W  
S????

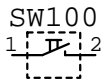

KEYRUBBER  
SW????

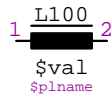

L  
L????

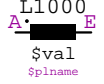

L\_  
L????

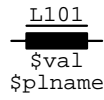

L\_FERRIT  
L????



L\_ZKB4182P  
L????

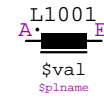

LE\_  
L?????

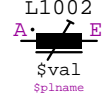

LET\_  
L?????



LF  
L????

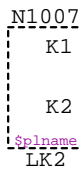

LK2  
N?????

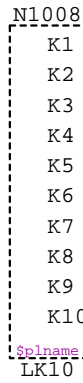

LK10  
N?????



NFM3POL  
L????

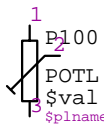

POTL  
P????

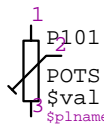

POTS  
P????

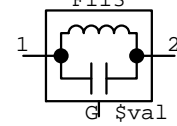

QUADDET  
FI???

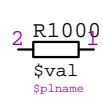

R  
R?????



R\_  
R?????

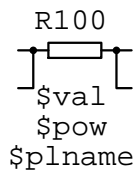

R\_4POL  
R????



R\_D  
R????

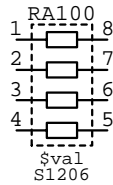

RA4\_S1206  
RA????

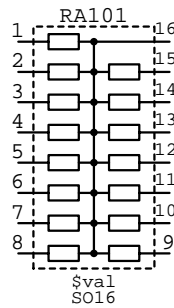

RA15\_S016  
RA????

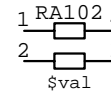

RA\_DIL4  
RA????



RA\_DIL4PP  
RA????

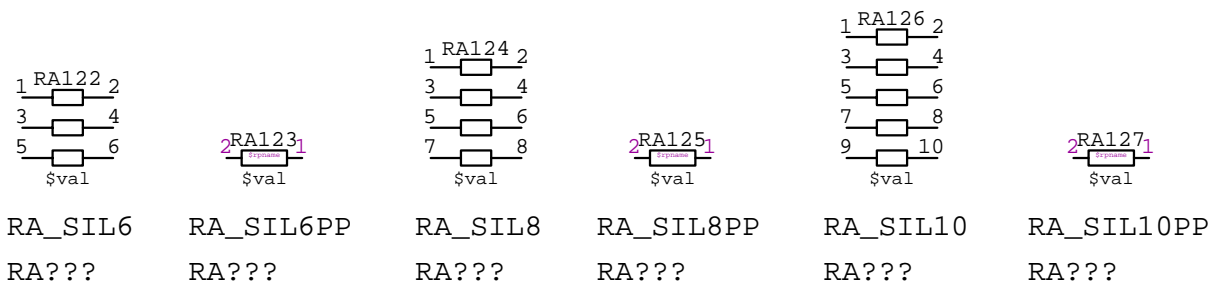
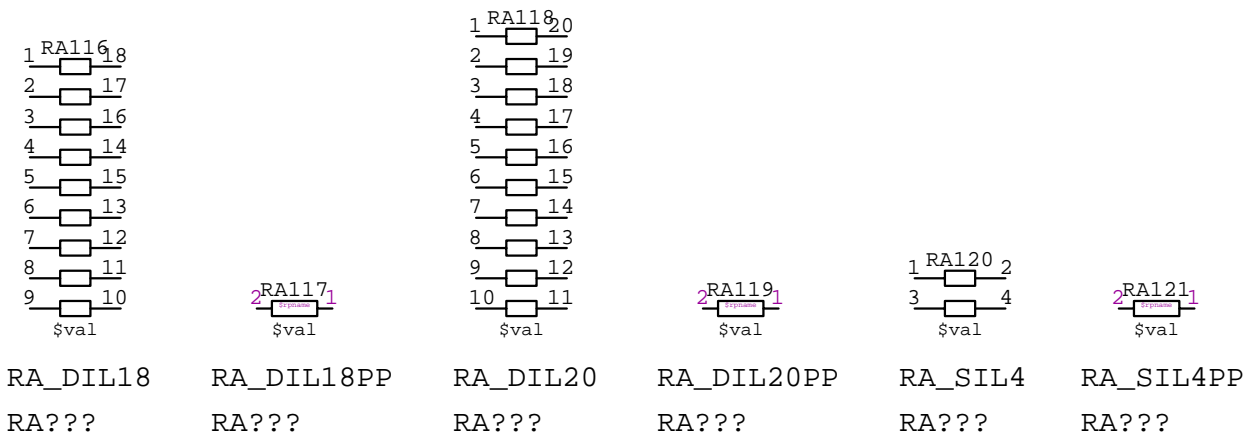
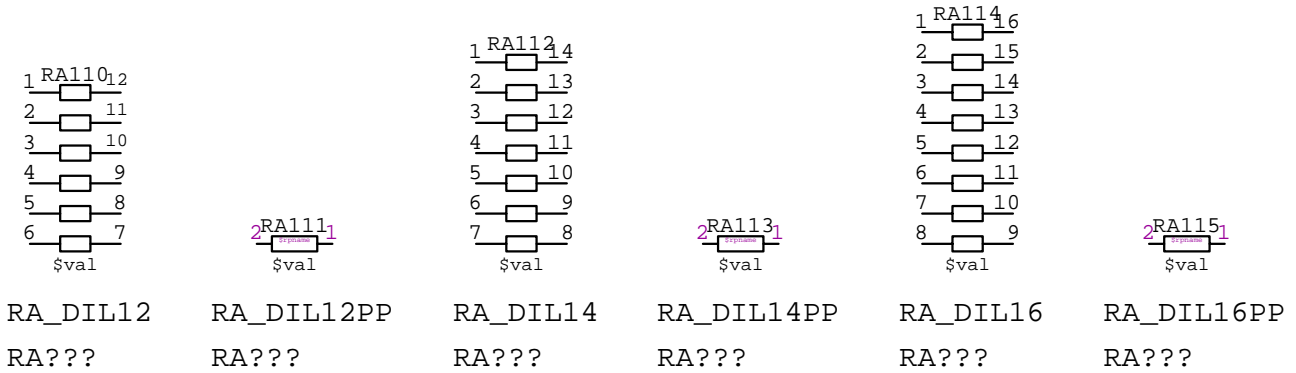
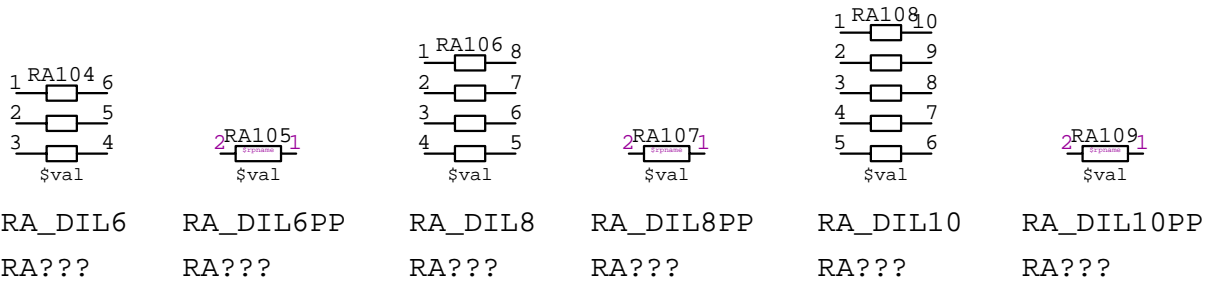

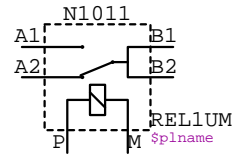
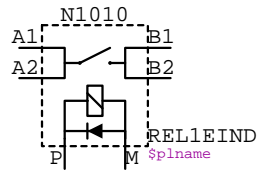
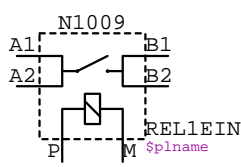
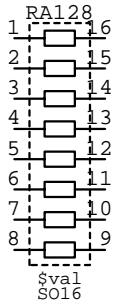

RA\_SO16  
RA???

REL1EIN  
N????

REL1EIND  
N????

REL1UM  
N????

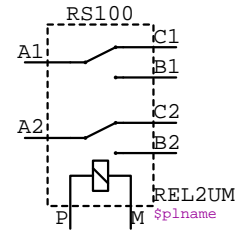
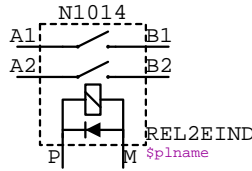
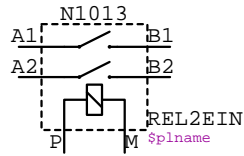
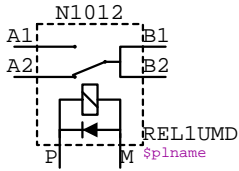

REL1UMD  
N????

REL2EIN  
N????

REL2EIND  
N????

REL2UM  
RS???

RES  
R???

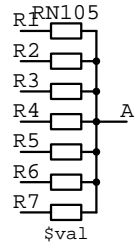
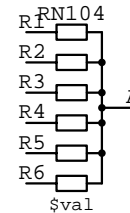
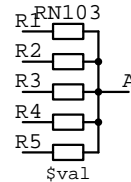
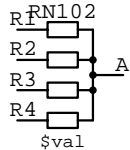
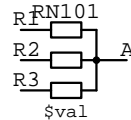
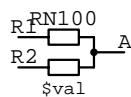
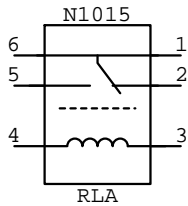

RLA  
N????

RN\_SIL3  
RN???

RN\_SIL4  
RN???

RN\_SIL5  
RN???

RN\_SIL6  
RN???

RN\_SIL7  
RN???

RN\_SIL8  
RN???

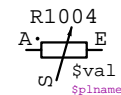
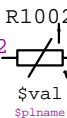
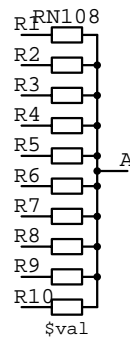
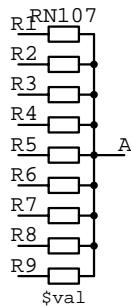
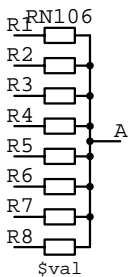

RN\_SIL9  
RN???

RN\_SIL10  
RN???

RN\_SIL11  
RN???

RNTC\_  
R????

RO\_  
R????

RP\_  
R????

RPO\_  
R????

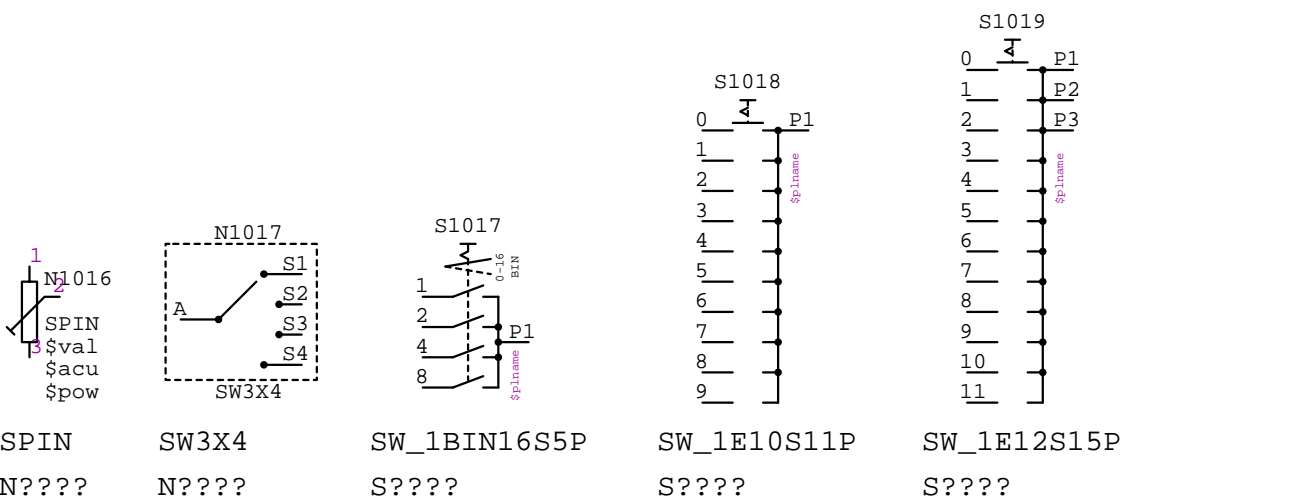
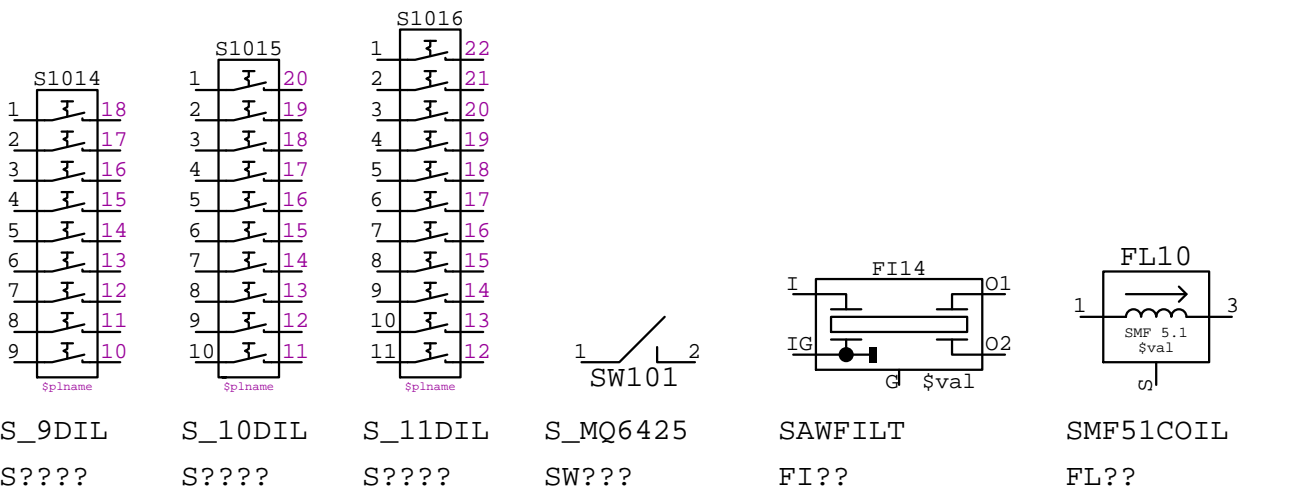
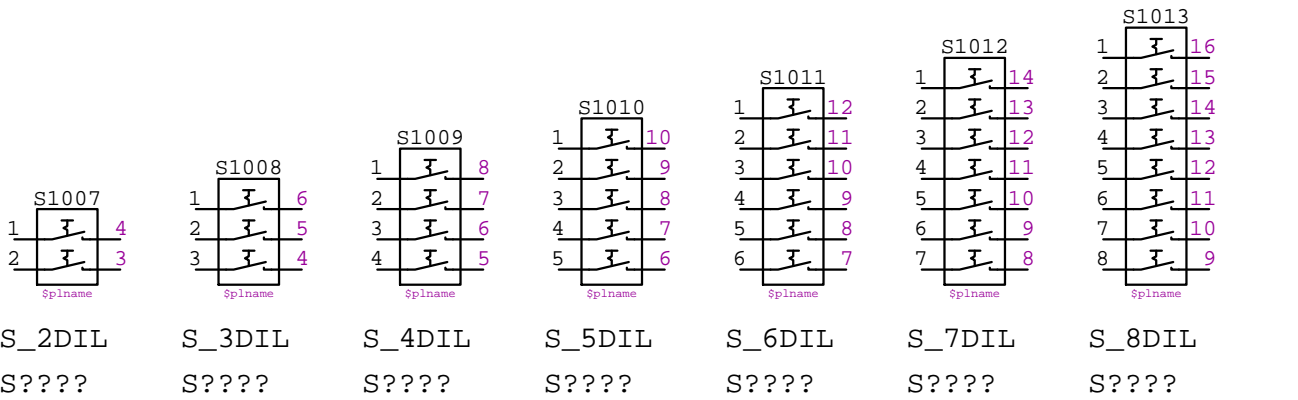
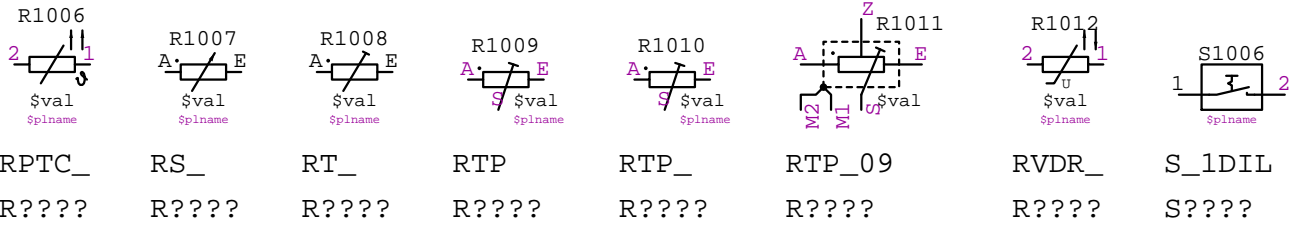

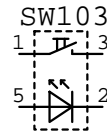
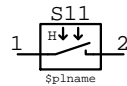
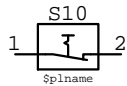
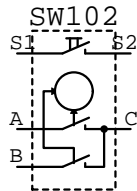
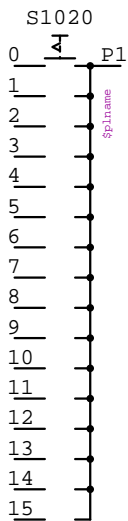

SW\_1E16S17P  
S????

SW\_D1511  
SW???

SW\_NC  
S??

SW\_REED  
S??

TASTLED  
SW???

TF\_1P1S  
TF???

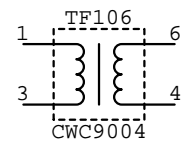
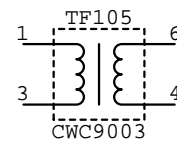
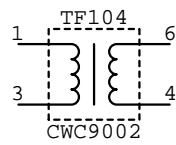
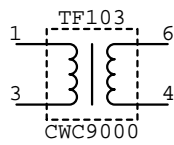
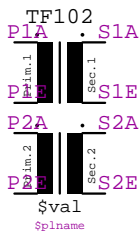
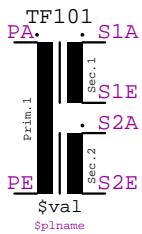

TF\_1P2S  
TF???

TF\_2P2S  
TF???

TF\_CWC9000  
TF???

TF\_CWC9002  
TF???

TF\_CWC9003  
TF???

TF\_CWC9004  
TF???

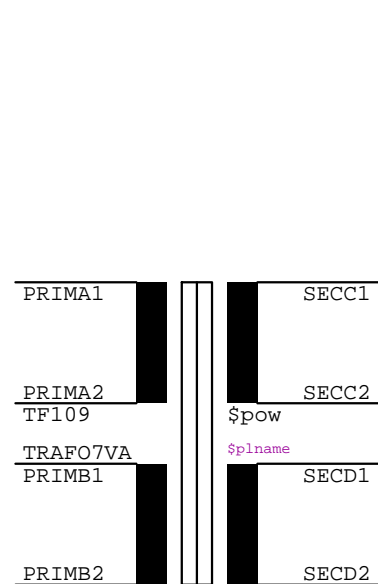
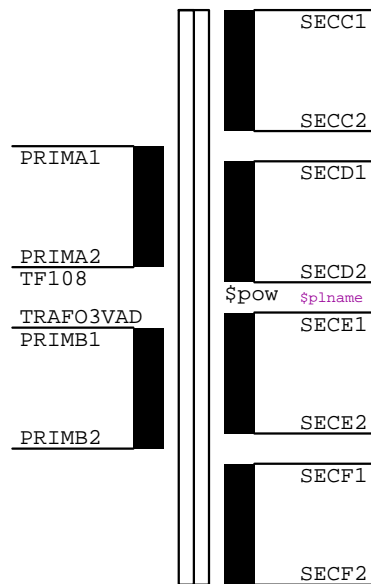
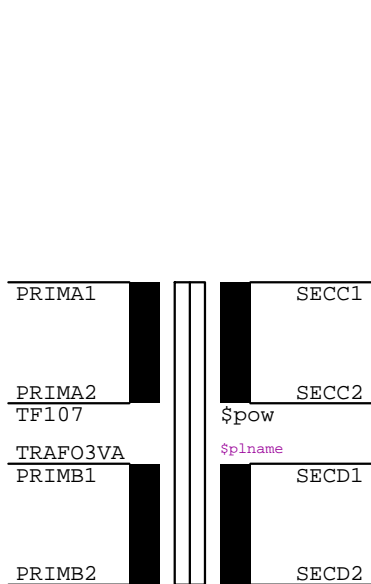

TRAF03VA  
TF???

TRAF03VAD  
TF???

TRAF07VA  
TF???

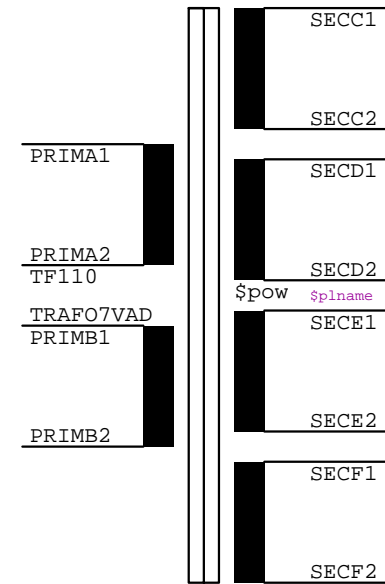

TRAF07VAD  
TF???

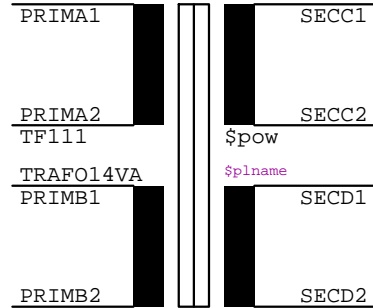

TRAF014VA  
TF???

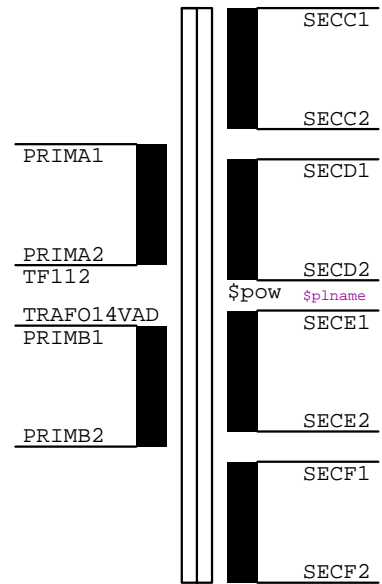

TRAF014VAD  
TF???

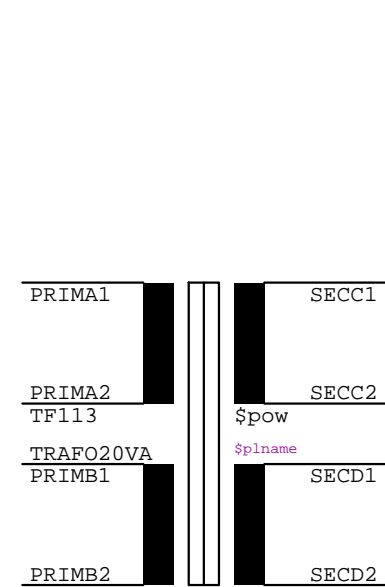

TRAF020VA  
TF???

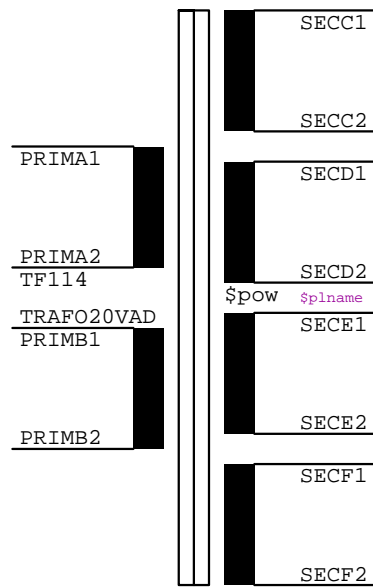

TRAF020VAD  
TF???



TRIMPOT  
P???